

ROGUE®

ROGUEFITNESS.COM

ROWER OWNER'S MANUAL

*Version 1.3
Safety | Technique | Monitor Set-Up | Maintenance | Storage*

IMPORTANT USE AND SAFETY NOTES

Failure to follow the below safety requirements may result in personal injury or damage to the machine.

BASIC SAFETY

- Consult your physician before beginning a new exercise program.
- Use only proper rowing technique while operating. (See page 3.) Alternate use or play on the Echo Rower can result in injury.
- Keep children and pets away from the Echo Rower. It has moving parts and can result in accidental injury.
- Do not use machine if any parts are damaged, worn out, or in a weak state. Use only genuine Rogue replacement parts.
- Injury can result from failure to follow the safety instructions

DURING USE

- Keep fingers, wires, and loose clothing away from seat rollers and roller tracks. The seat can roll over items in its path.
- Always use two hands while rowing. Do not use with only one hand, it puts an excessive stress on the chain and your body.
- Pull the chain straight back during your stroke. Pulling off-center, twisting, or rotating the chain can cause damage.
- Do not let go of the handle while rowing mid stroke. Carefully insert the handle in the handle rest or slowly retract the handle until the chain is fully retracted.
- Replace work or broken parts as soon as possible. **DO NOT** use the machine until they are replaced.

The Rogue Echo Rower is designed for usage class rating S for professional, institutional and/or commercial use, and Accuracy Class "A" for High Accuracy Training Data, as defined per ISO 20957-1 Safety Standards. Testing parameters: Lab tested on dynamometer using full range of motion on all dampers settings (1-10) and at /500m pace 1:33 and 2:00.

STORAGE AND SET-UP

- Find a level area to use the Echo Rower. Be sure all legs have steady contact with the ground and the rower is stable.
- Always lock the frame using the framelock before moving the rower.
- **DO NOT** stand the Echo Rower up on its base or lean against anything, it could fall.
- **DO NOT** bolt the Echo Rower to the ground, or damage/modify the frame in any way, including adding fasteners.
- **USE CAUTION** while assembling, when attaching the monorail to the flywheel, and when locking/unlocking the framelock.

DIMENSIONS AND WEIGHT CAPACITY

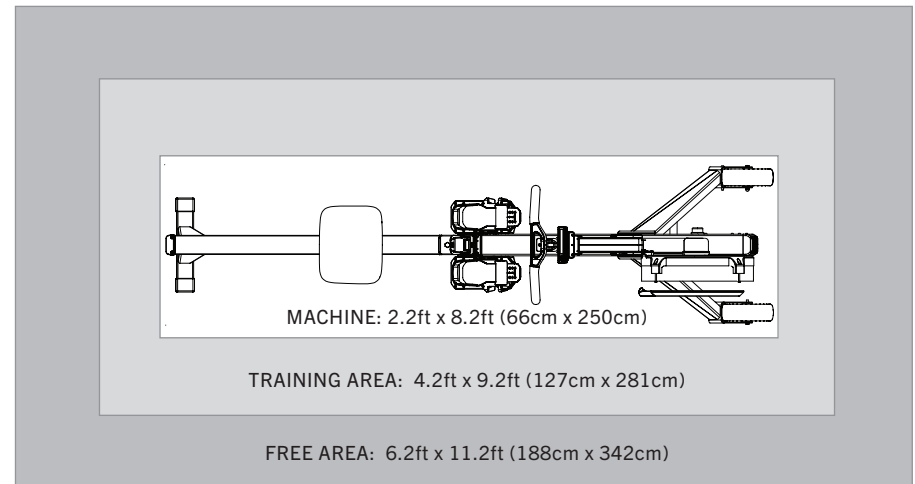

WEIGHT CAPACITY: 500 lb (227 kg)

PROPER ROWING TECHNIQUE

The rowing stroke has four phases, listed below. As you move through them, keep your head in a neutral position and your shoulders low. Movement through the phases should be seamless and fluid. The drive phase (when you push off and pull) should be powerful, while the rest of the phases should be smooth and controlled.

Good technique is more important than speed or resistance. Poor form can lead to injury and less effective workouts. Breathe steadily throughout the stroke. Exhale during the Drive and inhale during the Recovery. Keep your core muscles tight throughout the stroke to protect your lower back and maintain proper posture.

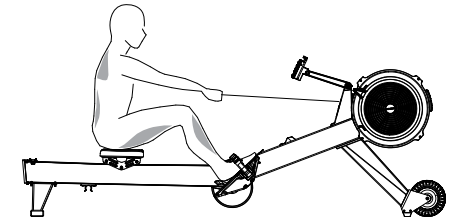
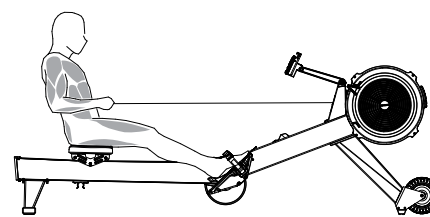
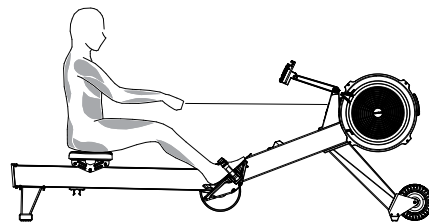
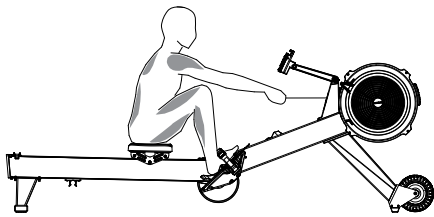

1. THE CATCH

- **Position:** Sit with your knees bent and your shins vertical. Your torso should be slightly leaned forward with your arms fully extended and the handle close to your chest.
- **Grip:** Hold the handle with a grip that's comfortable but firm, your palms facing down.
- **Feet:** Heels may lift or stay flat.

2. DRIVE

- **Legs:** Push off with your legs, straightening them while keeping your core engaged.
- **Torso:** As your legs straighten, lean back slightly (but not excessively) from your hips.
- **Arms:** Pull the handle towards your chest. Your elbows should bend and stay close to your body. Your hands should move towards your lower ribs.

3. FINISH

- **Position:** You should be leaning back slightly with your legs fully extended and the handle pulled into your chest. Your elbows should be bent and your forearms almost parallel to the floor.

4. RECOVERY

- **Arms:** Extend your arms back out, allowing the handle to move away from your chest.
- **Torso:** Lean forward from your hips, returning to the starting position.
- **Legs:** Bend your knees and slide forward on the seat to return to the Catch position.

MONITOR SET-UP

INSTALL BATTERIES

1.

Remove the battery cover from the console by using the provided Phillips head screwdriver to remove the four screws.

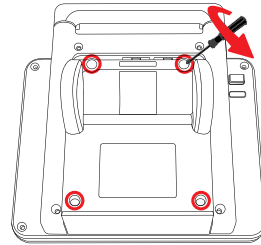

2.

Install 2 D-cell (1.5v) batteries aligning positive and negative ends with the corresponding symbols.

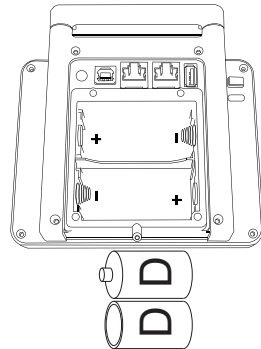

3.

Reattach the battery cover with the four screws fastened in place.

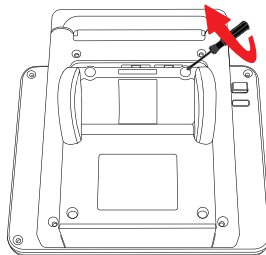

Note: Remember to remove the batteries from the monitor when not in use for a period of 3 months or more.

BUTTONS AND PORTS ON BACK OF MONITOR

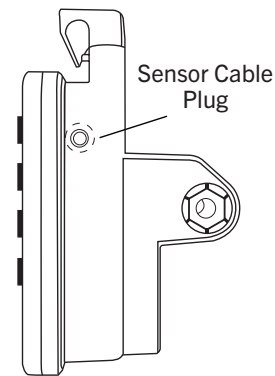
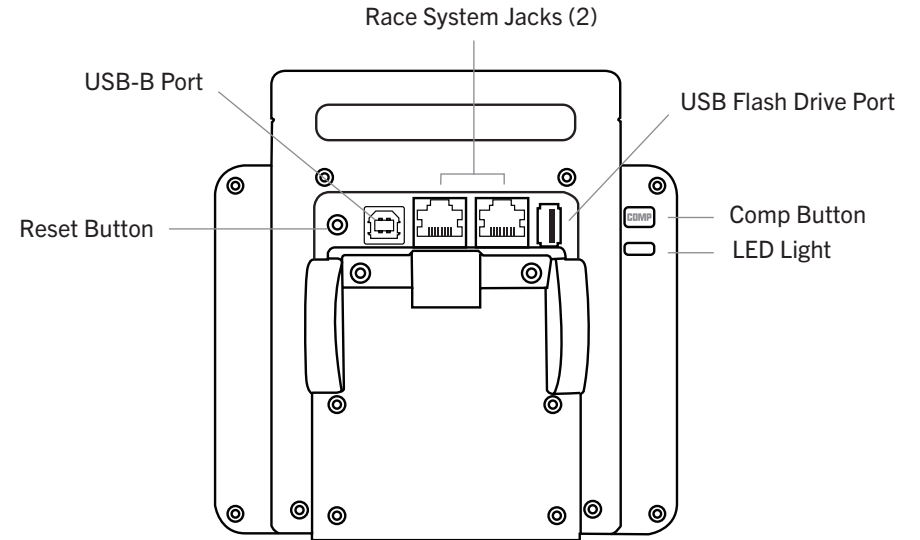

SIDE VIEW

RESET BUTTON: Used to factory reset the device. Hold down the DISPLAY and UNITS buttons on the front while you press and release the RESET button on the back of the console using a paper clip. Continue holding the buttons down for at least 7 seconds. When the display shows “Setting Factory Defaults” release the buttons. (Note this will erase all stored data.)

RACE SYSTEM JACKS: Used for connecting multiple rowing machines for racing.

COMP BUTTON: Used to activate Competition Mode. Hold down 2 seconds. In this mode, console time out will change to 12 hours.

LED LIGHT: Turns on when Competition Mode is active.

SENSOR CABLE PLUG: Plug sensor cable coming from the rower into this plug.

MONITOR DISPLAYS

MAIN MENU

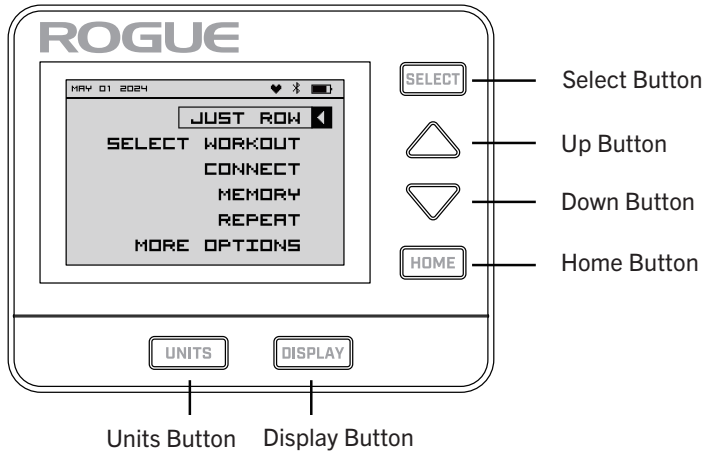

Select Button: Select an option

Up Button: Moves Selector up or increases a value setting

Down Button: Moves Selector up or increases a value setting

Home Button: Prompts to end workout/returns previous page

Units Button: Press during workout to change data units (4 options)

Display Button: Press during workout to change data displays (5 options)

Sleep Mode: Return to the main menu and then press Home Button 4 times to turn console off

WORKOUT SCREEN

Displays distance rowed (m), watts, time/500m, or cal/hour. In interval workout rest mode, current interval number is displayed

Time elapsed, remaining workout time, watts, calories or /500m pace

Average time/500m in current workout, average watts, or total calories

Estimated distance /30 minutes. In interval workout mode or single target workout mode, displays target estimate finish time or distance. In interval rest mode, displays total finish distance

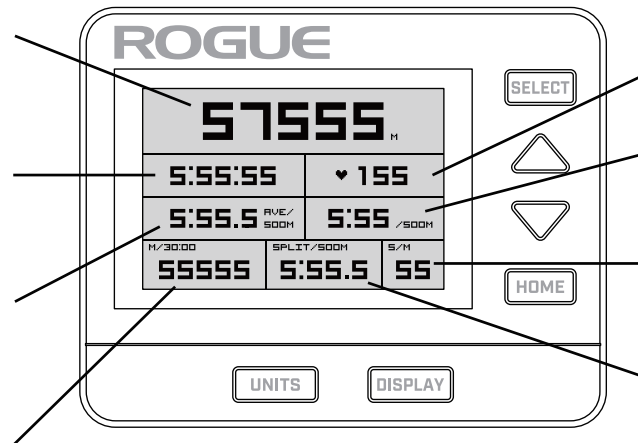

Heart Rate (if connected to a device)

Time /500m, watts, calories, calories/hour. In interval mode, remaining rest time is displayed

Strokes per minute

Split workout results. In interval mode, interval number is displayed

GETTING STARTED

BEGINNING TO ROW

- **ADJUST THE FOOT STRAPS:** Sit on the rowing machine and adjust the foot straps so that your feet are securely strapped in. The straps should be over the balls of your feet, not the toes.
- **SET THE DAMPER:** Start with a lower setting (3-5) if you're new to rowing. You can adjust it based on your comfort and fitness level.
- **SELECT YOUR WORKOUT:** Choose a workout or set a target (time, distance, or calories) on the monitor.
- **FOCUS ON PROPER POSTURE AND TECHNIQUE.**

EASE INTO YOUR WORKOUT PLAN

- Stretch and warm up before workouts.
- Master your form and technique and let your body adjust for about a week.
- Don't overdo it. Avoid starting out at full force/speed. Higher intensity and longer duration workouts will be easier for you over time but trying to complete them too quickly could result in injury and set you back on your fitness goals.

TRACK YOUR NUMBERS

- Monitoring your progress and setting personal goals can help keep you engaged and motivated.

ADJUST YOUR MACHINE

Both the Damper and Footstraps should be adjusted.

DAMPER: Allows you to adjust the intensity and feel of your workout by regulating airflow to the flywheel, helping you tailor your rowing experience to your fitness goals. The damper setting affects the feel of the stroke but doesn't change the mechanical resistance. Adjust the damper to suit your fitness goals and personal preference.

Higher Damper Settings: For a power-focused workout. Mimics rowing in a heavy, slow-moving boat or conditions where you have more water resistance. This setting gives a more intense workout, emphasizing power and strength.

Lower Damper Settings: For endurance and speed training. Simulates rowing in a faster, lighter boat where resistance is less. This setting is often used for endurance training and allows for faster stroke rates.

FOOT STRAP LEVER: Should be used for quick entry and exit. Do not clamp down hard on your feet. The foot strap should be at a comfortable tension. **To set the tension:** With the lever closed (down), tighten the buckle so it is just barely snug, but not tight or uncomfortable. After the tension is set you can exit and enter the foot straps by using only the quick release lever.

CHAIN HEIGHT INDICATOR: (optional coaching tool) Position the indicator to your desired chain height. The indicator gives you visual feedback on how much vertical movement you have in your stroke.

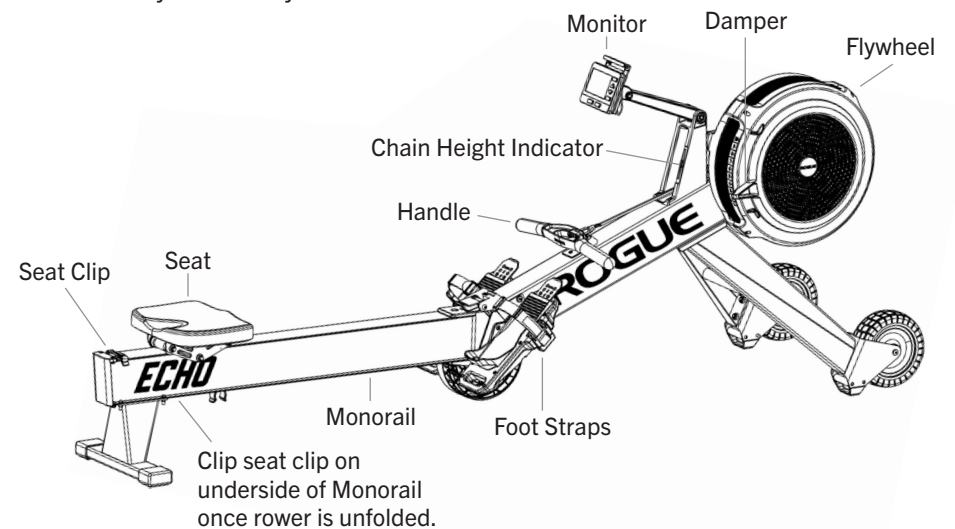

RECOMMENDED MAINTENANCE

ON A REGULAR BASIS

Like your computer, the monitor needs to download periodic updates to run smoothly. Use the Device Manager option within the MORE section of the Rogue APP to connect and update your devices via Bluetooth. It is available on Mac/iOS and Android and is free through the App Store or Google Play.

DAILY

Wipe down the machine's seat and monorail after use with a damp cloth. DO NOT use bleach, harsh solvents, or scrubs.

EVERY 50 HOURS OF USE (weekly for gyms and other facilities)

Lubricate the entire chain with approximately 1 tsp. of mineral oil, 20W motor oil, or 3-IN-ONE® on a paper towel. Wipe off the excess and test the chain. Repeat if necessary until chain glides smoothly. Do not use unapproved lubricants or solvents, including WD-40®.

EVERY 250 HOURS OF USE (monthly for gyms and other facilities)

1. **Inspect Chain.** If rust or stiff links are present, replace.
2. **Tighten the Elastic Cord:** The handle should return all the way to the fan enclosure without any slack.
3. **Inspect Handle/Chain Connection.** If the U-bolt is worn halfway through, the hole has widened, or the connection seems weak, the entire connection should be replaced.
4. **Check for and remove dust:** A flashlight, canned air, or a small vacuum may be helpful to reach dust inside the seat rail track.
5. **Check Screws and Console Arm Joints.** Tighten or loosen, if necessary, until the console is stable as well as adjustable.

WARNING! If repairs are required, do not use the machine until necessary adjustments or replacements have been made. Failure to maintain and inspect your rower may result in poor performance and injury.

STORAGE AND TRANSPORT

DESIGNED TO MOVE

The Echo Rower is intended to accommodate outdoor workouts and events. You may lift or wheel the rower.

FOLDING YOUR ECHO ROWER

1. Clip the seat clip on to the top of the monorail track. Position it behind the seat on the track so that it prevents the seat from rolling back.
2. Lift the lock latch labeled "PULL" in the center of the rower.
3. Then lift the latch labeled "LIFT"
4. Lift the center of the rower up and grab the handle at the base of the footrests.
5. Keep lifting, letting the rower fold.
6. Use your foot to control the wheel. Prevent it from rolling toward you too fast.

Remove batteries if storing for more than 3 months.

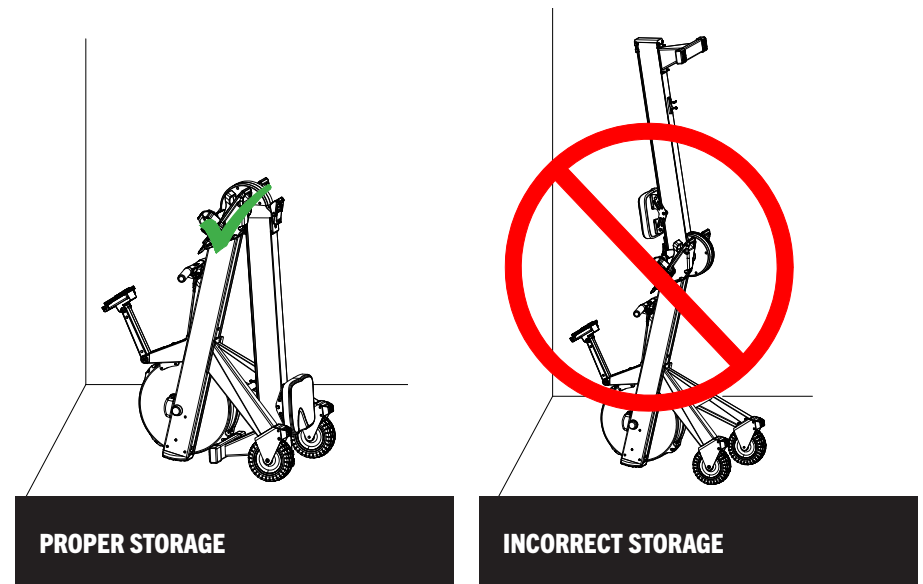

- Monorail folded at hinge near foot straps
- Base, flywheel, and wheels resting against floor

- DO NOT lift the rower up and lean against objects/walls.

ROGUE[®]

WARRANTY

Echo Rowers are guaranteed by a limited 2 year & 5 year warranty. For complete warranty information, contact Rogue support.